

Tartu Do

Do ja Altia noorteturniir Weight category: E-klass -21 kg

	1	2	3	4	5	6	Games won	Pl.
							Gameresults	
TIIRIK, Karl [Merike (EST)]	0		2		0		2	3
	0		10		0		10	
LEOPARD, Andre [Merike (EST)]	2			0		2	4	2
	7			0		7	14	
MOPPEL, Erik [Merike (EST)]		2		2	2		6	1
		10		10	1		21	
KALBERG, Taavet [Riina (EST)]		0	0			0		4
		0	0			0		

Tartu Do
Do ja Altia noorteturniir
Weight category: E-klass -23 kg

	1	2	3	Games won	Pl.
				Gameresults	
RAND, Karl Kenneth [Merike (EST)]	0	0			3
	0	0			
KIRS, Marvet [Ats (EST)]	2		2	4	1
	10		7	17	
LELOV, Kauri [Juhan (EST)]		2	0	2	2
		7	0	7	

Tartu Do

Do ja Altia noorteturniir

Weight category: E-klass -25 kg

	1	2	3	4	5	6	7	8	9	10	Games won	Pl.
											Gameresults	
ANGERJÄRV, Karlos [Jaan (EST)]	2		0			2			0		4	3
	7		0			7			0		14	
PECHTER, Kalju Yuan [Jaan (EST)]	0			0			0			0		5
	0			0			0			0		
JALAKAS, Jako [Priit (EST)]		0		2		0		0			2	4
		0		7		0		0			7	
MÄGI, Ragnar [Evelin (EST)]		2			0		2		2		6	2
		7			0		5		7		19	
ALAJÕE, Mikk [Andre (EST)]			2		2			2		2	8	1
			1		10			7		10	28	

Tartu Do

Do ja Altia noorteturniir

Weight category: E-klass -27 kg

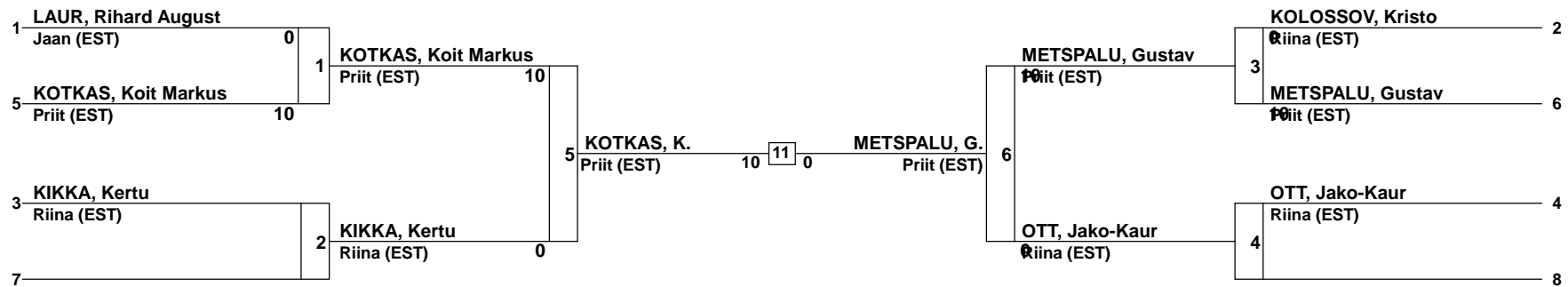

1 ^e	KOTKAS, Koit Markus	Prii
2 ^e	METSPALU, Gustav	Prii
3 ^e	OTT, Jako-Kaur	RIIN
3 ^e	KOLOSSOV, Kristo	RIIN

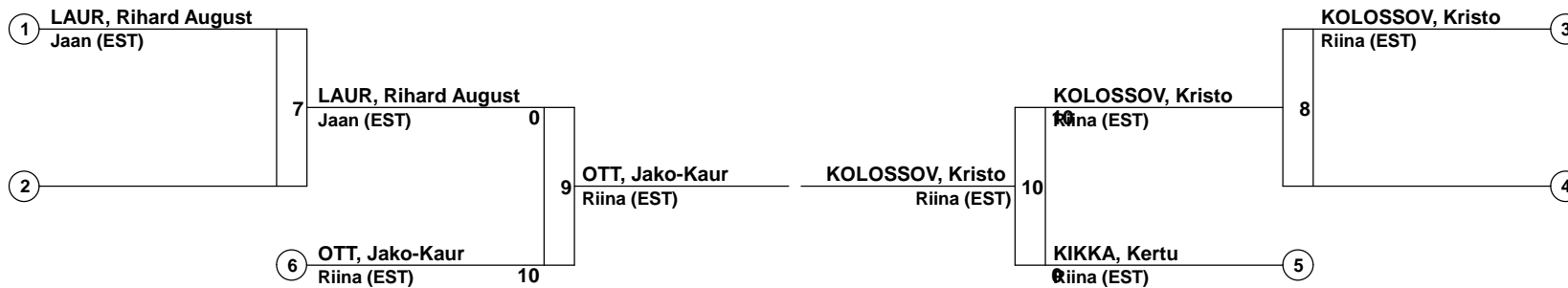

Tartu Do

Do ja Altia noorteturniir

Weight category: E-klass -30 kg

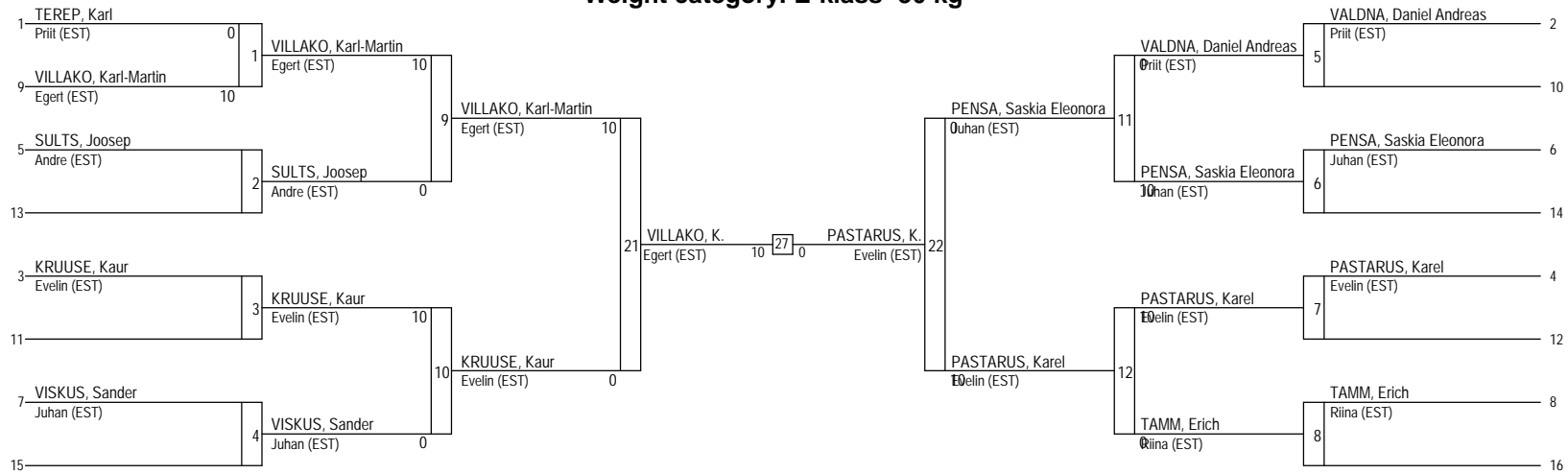

1^e	VILLAKO, Karl-Martin	EGER
2^e	PASTARUS, Karel	Eve
3^e	TEREP, Karl	Prii
3^e	KRUUSE, Kaur	Eve

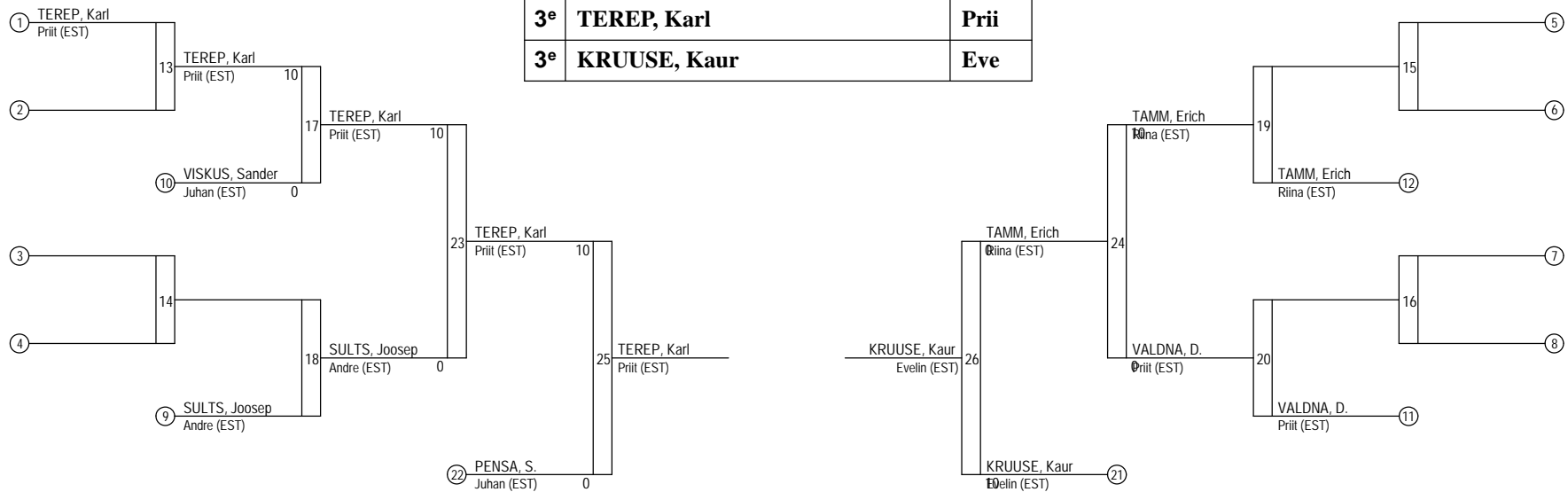

Tartu Do
Do ja Altia noorteturniir
Weight category: E-klass -34 kg

	1	2	3	Games won	Pl.
				Gameresults	
SAAR, Ken Marten [Priit (EST)]	2	2		4	1
	10	10		20	
SARAPSON, Deiro [Evelin (EST)]	0		2	2	2
	0		7	7	
LEPNURM, Mathias [Juhan (EST)]		0	0		3
		0	0		

Tartu Do

Do ja Altia noorteturniir *Weight category: E-klass -38 kg*

	1	Games won	Pl.
		Gameresults	
PLOOM, Axel [Juhan (EST)]	0		2
	0		
TOOMING, Ott [Juhan (EST)]	2	2	1
	10	10	

Tartu Do

Do ja Altia noorteturniir

Weight category: E-klass +38 kg

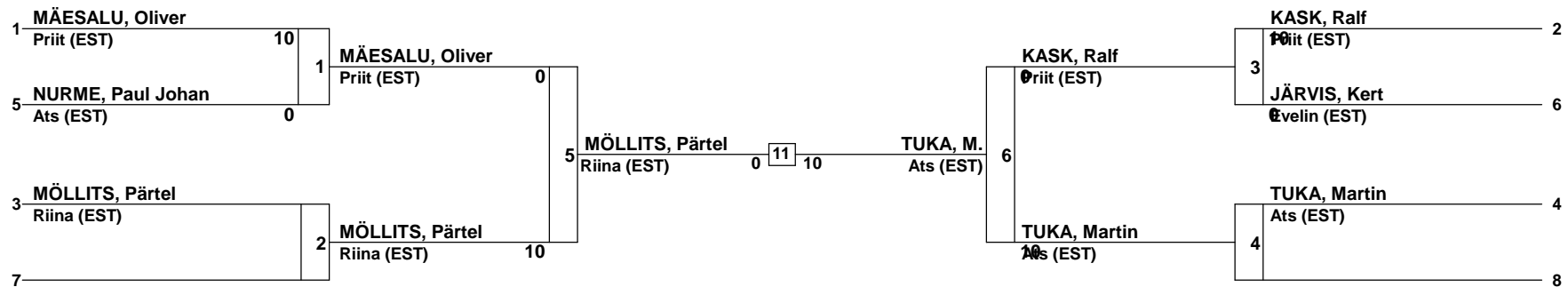

1 ^e	TUKA, Martin	Ats
2 ^e	MÖLLITS, Pärtel	RIIN
3 ^e	KASK, Ralf	Prii
3 ^e	MÄESALU, Oliver	Prii

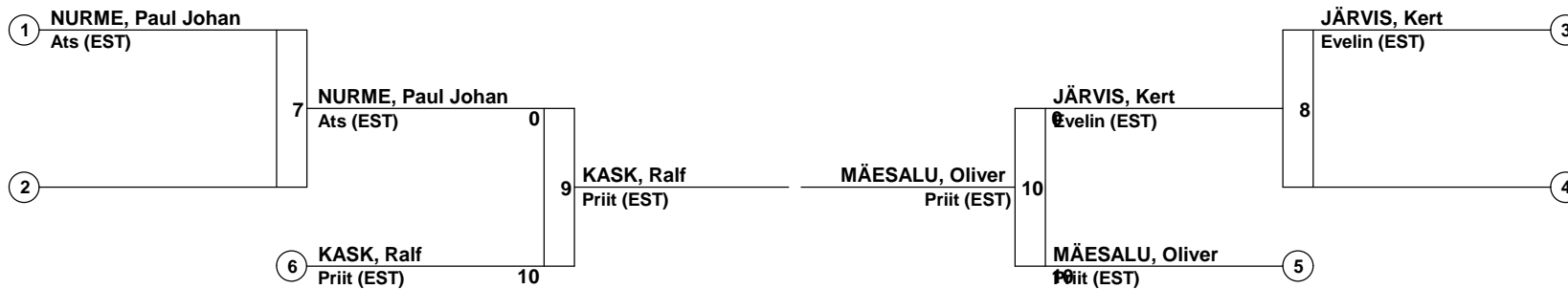

Tartu Do

Do ja Altia noorteturniir Weight category: D-klass -27 kg

	1	2	3	4	5	6	Games won	Pl.
							Gameresults	
LIAS, Rebeka [Juhan (EST)]	0		0		0			4
	0		0		0			
LOND, Germo [Ats (EST)]	2			0		0	2	3
	5			0		0	5	
PÄRNA, Kerdo [Ats (EST)]		2		2	2		6	1
		10		10	7		27	
KEPS, Kristjan [Evelin (EST)]		0	2			2	4	2
		0	5			10	15	

Tartu Do

Do ja Altia noorteturniir

Weight category: D-klass -30 kg

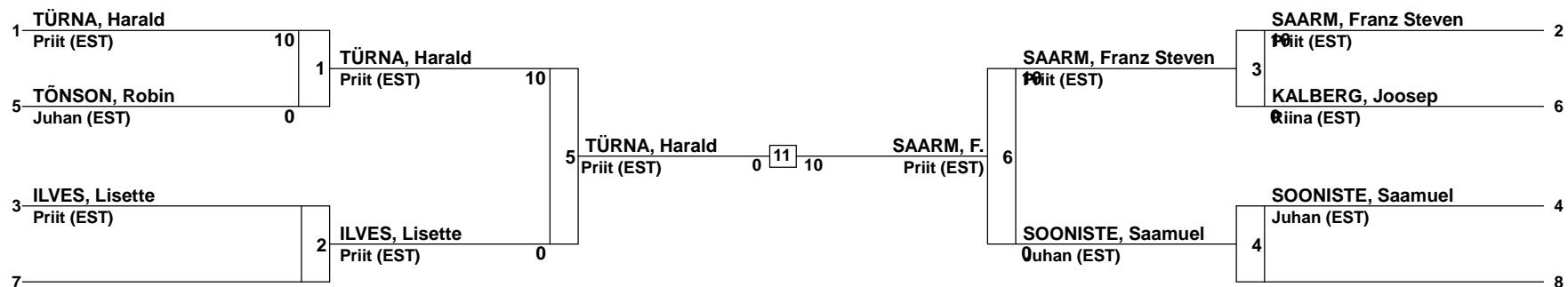

1 ^e	SAARM, Franz Steven	Prii
2 ^e	TÜRNAS, Harald	Prii
3 ^e	SOONISTE, Saamuel	Juh
3 ^e	KALBERG, Joosep	RIIN

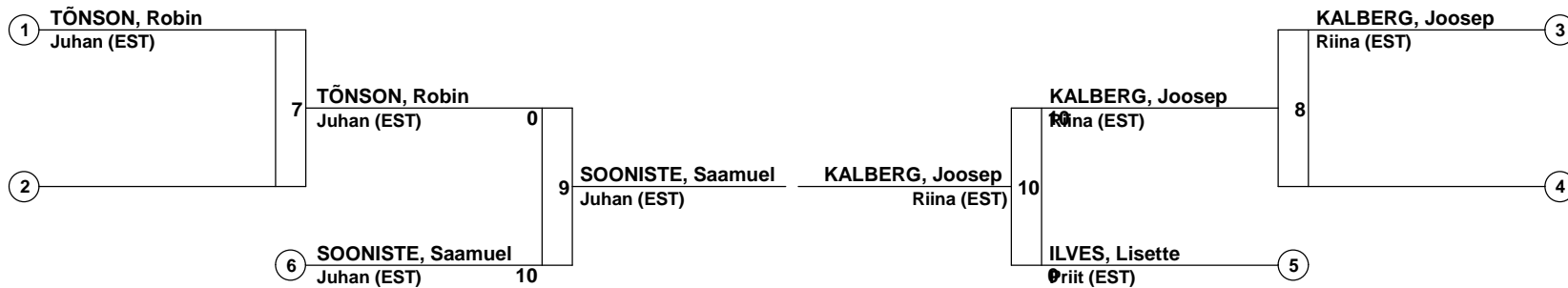

Tartu Do

Do ja Altia noorteturniir

Weight category: D-klass -34 kg

	1	2	3	4	5	6	7	8	9	10	Games won	Pl.
	Gameresults											
KRUUSE, Ott [Evelin (EST)]	2		2			2			2		8	1
	10		10			7			10		37	
ROHTMETS, Kaarel [Jaan (EST)]	0			0			0			0		5
	0			0			0			0		
NÕMMIK, Karl Robert [Priit (EST)]		2		2		0		0			4	3
		10		10		0		0			20	
EHRLICH, Jan-Eerik [Priit (EST)]		0			0		2		0		2	4
		0			0		5		0		5	
LAMP, Minni Riin [Juhan (EST)]			0		2			2		2	6	2
			0		10			7		10	27	

Tartu Do
Do ja Altia noorteturniir
 Weight category: D-klass -38 kg

	1	2	3	Games won	Pl.
				Gameresults	
MÄGI, Airon-Mattias [Evelin (EST)]	2	2		4	1
	10	10		20	
KUKK, Jass-Andreas [Ats (EST)]	0		2	2	2
	0		10	10	
KÜÜNAL, Lauri [Priit (EST)]		0	0		3
		0	0		

Tartu Do

Do ja Altia noorteturniir Weight category: D-klass -42 kg

	1	2	3	4	5	6	Games won	Pl.
							Gameresults	
KÕRGVEE, Kaarel [Riina (EST)]	0		2		0		2	3
	0		10		0		10	
SAAR, Karl Markus [Priit (EST)]	2			2		2	6	1
	10			10		10	30	
TAJOKIN, Artjom [Priit (EST)]		2		0	2		4	2
		10		0	5		15	
ORUPÕLD, Märt [Priit (EST)]		0	0			0		4
		0	0			0		

Tartu Do

Do ja Altia noorteturniir

Weight category: D-klass +42 kg

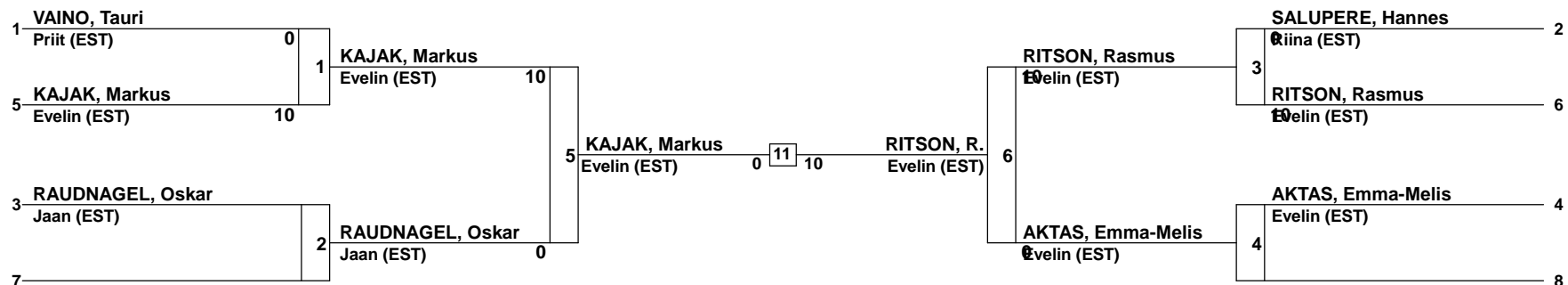

1 ^e	RITSON, Rasmus	Eve
2 ^e	KAJAK, Markus	Eve
3 ^e	VAINO, Tauri	Prii
3 ^e	RAUDNAGEL, Oskar	Jaa

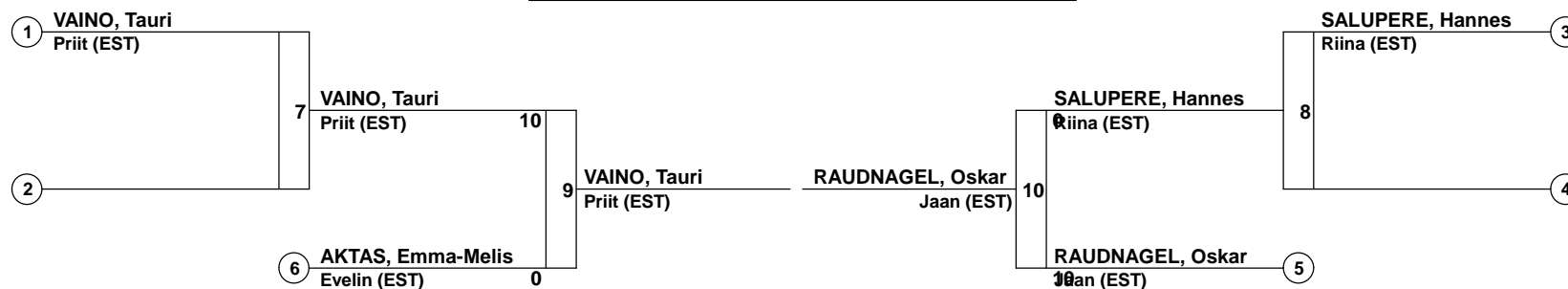

Tartu Do

Do ja Altia noorteturniir

Weight category: C-klass -45 kg

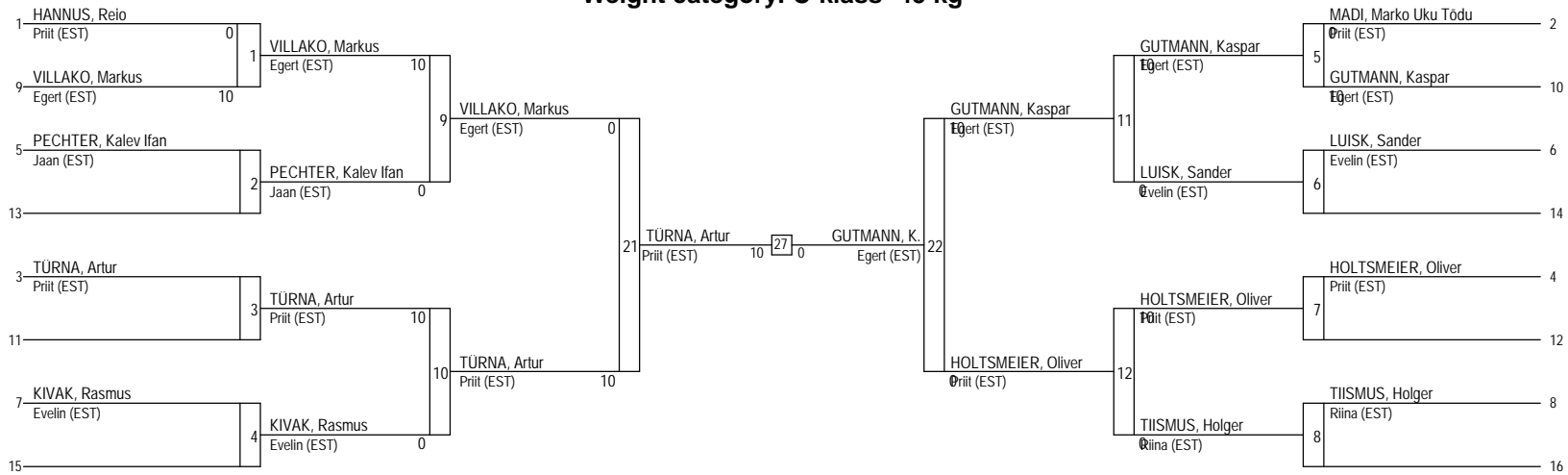

1^e	TÜRNAS, Artur	Prii
2^e	GUTMANN, Kaspar	EGER
3^e	HOLTSMEIER, Oliver	Prii
3^e	VILLAKO, Markus	EGER

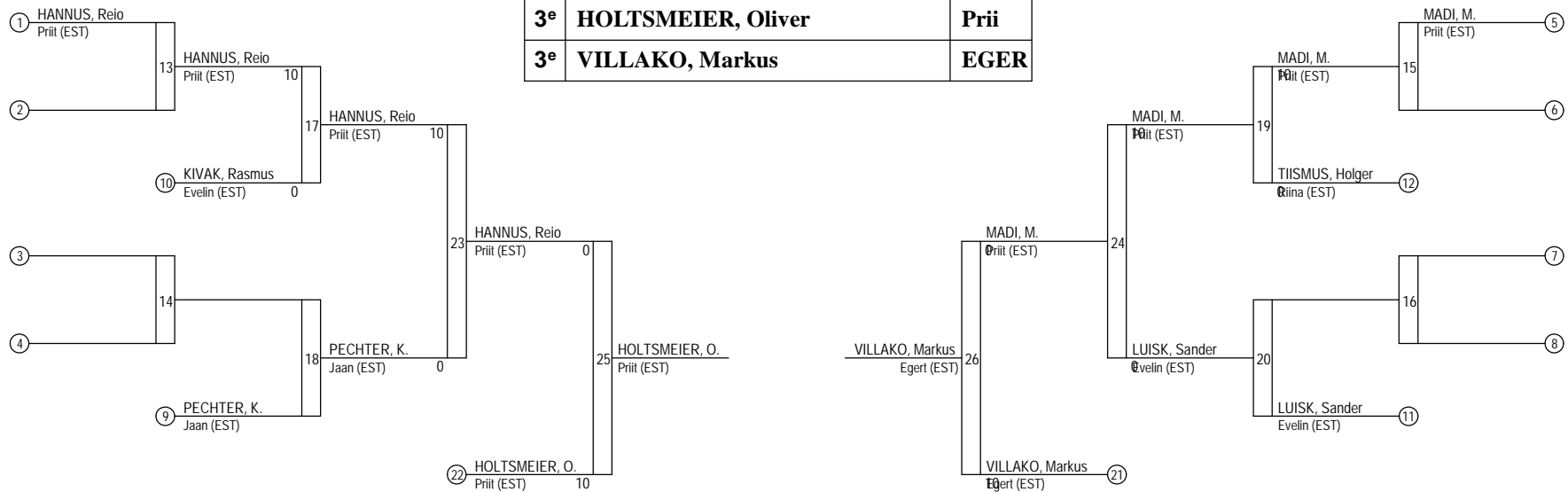

Tartu Do

Do ja Altia noorteturniir

Weight category: C-class -60 kg

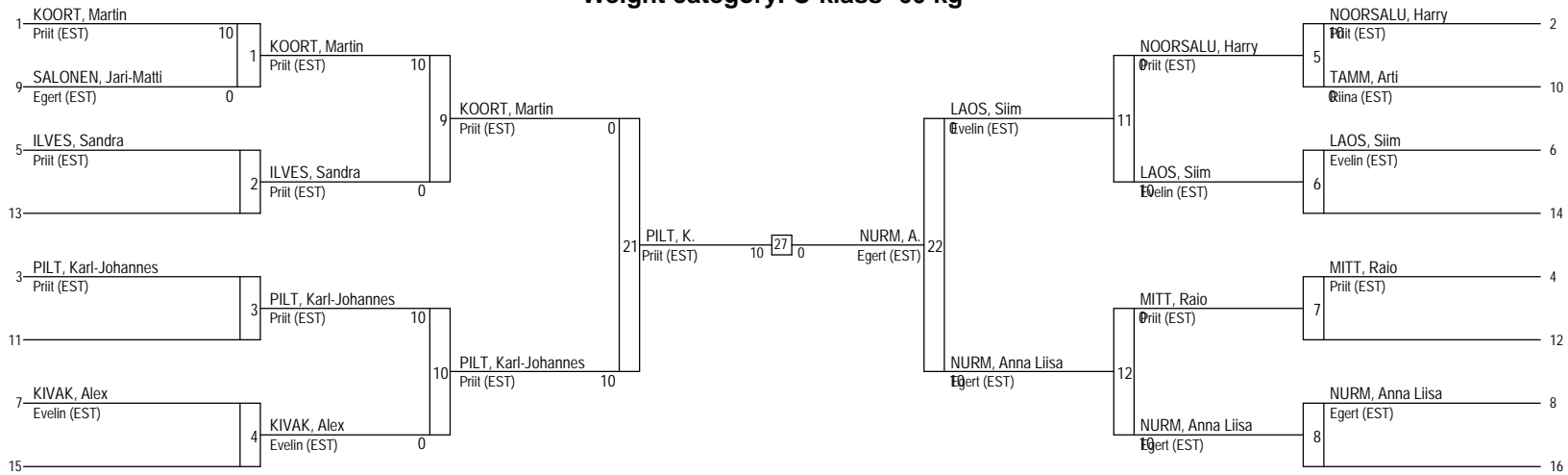

1^e	PILT, Karl-Johannes	Prii
2^e	NURM, Anna Liisa	EGER
3^e	KIVAK, Alex	Eve
3^e	MITT, Raio	Prii

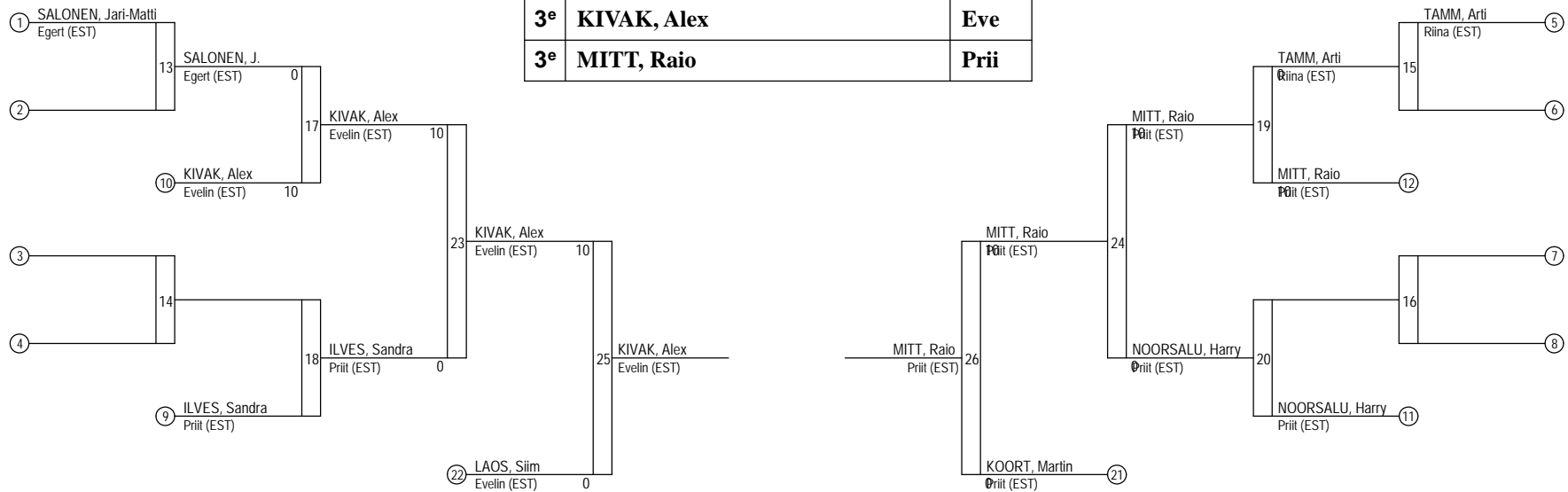

Tartu Do

Do ja Altia noorteturniir

Weight category: C-klass +60 kg

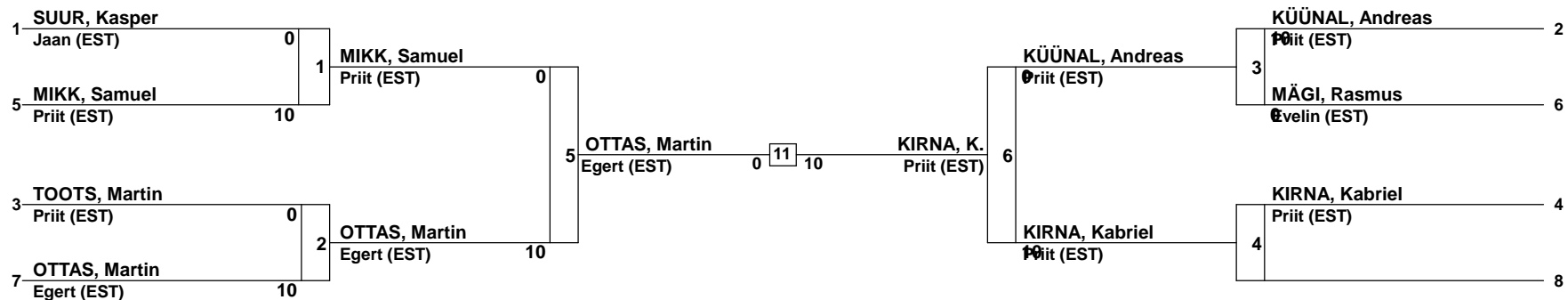

1 ^e	KIRNA, Kabriel	Prii
2 ^e	OTTAS, Martin	EGER
3 ^e	TOOTS, Martin	Prii
3 ^e	MIKK, Samuel	Prii

